

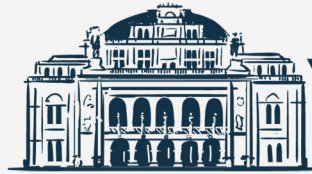

ENERJİ VERİMLİLİĞİNİN GELECEĞİ

- 21 mm Temperli Isıcam
- Dişli-Zincir ve Flat Belt(Triger Kayış) Sistem Seçenekleri
- Secustik Kilit
- Hareketli Küpeşte Özelliği İle Güvenli Kapatma
- EPDM Conta ve Kıl Fitol
- Yeni Nesil Ergonomik Tasarım
- Maksimum Su ve Hava Geçirmezlik
- Üstün Isı ve Ses Yalıtımı
- Temizlenebilir
- 2.2 mm Güçlendirilmiş Alüminyum Profiller



VIENNA

GİYOTİN



PROFİLLER

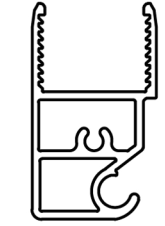

V-952
786 gr/m
ÜST YATAY BAZA

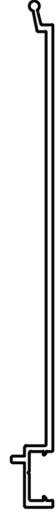

PR-2743
896 gr/m
ŞASE KAPAK

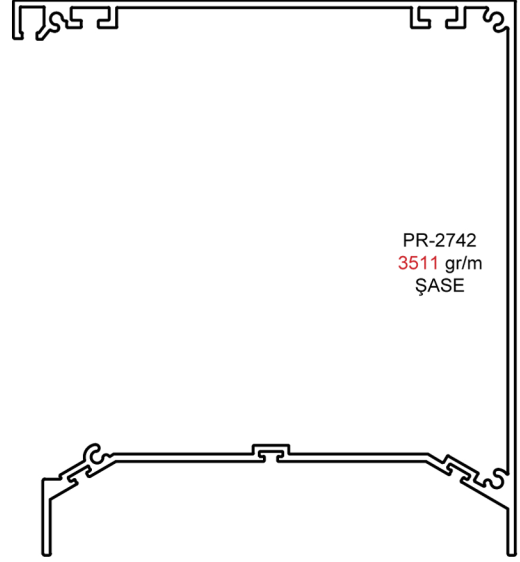

PR-2742
3511 gr/m
ŞASE

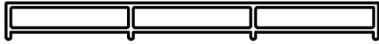

PR-2761
1092 gr/m
ALT KASA



V-951
1312 gr/m
HAREKETLİ KÜPEŞTE

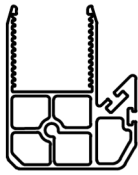

V-957
1029 gr/m
ALT YATAY BAZA

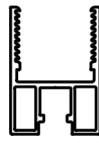

V-958
585 gr/m
DİKEY BAZA



V-953
418 gr/m
HAREKETLİ KENET



PROFİLLER



V - 962
1166 gr/m
YAN DİKME

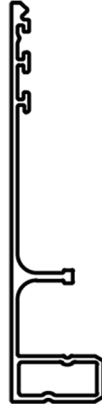

V-956
605 gr/m
YAN DİKME KAPAK

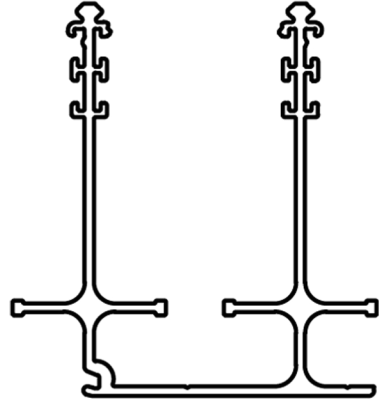

V-961
1565 gr/m
ARA KLAVUZ



V-955
382 gr/m
SABİT KENET

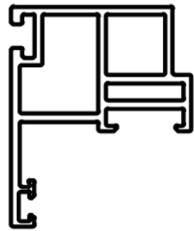

V-954
1132 gr/m
VASİSTAS KASA

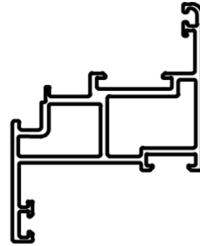

V-959
1171 gr/m
VASİSTAS KANAT



V-960
199 gr/m
ÇİFTCAM ÇİTA



DETAY



DİZİLİM DETAYLAR

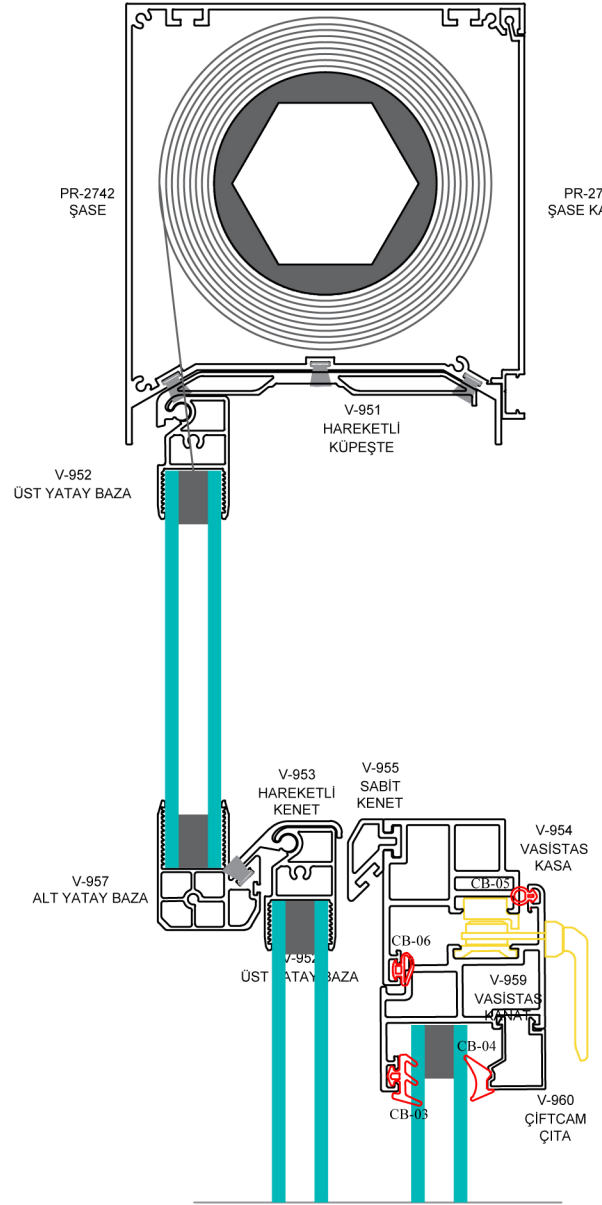
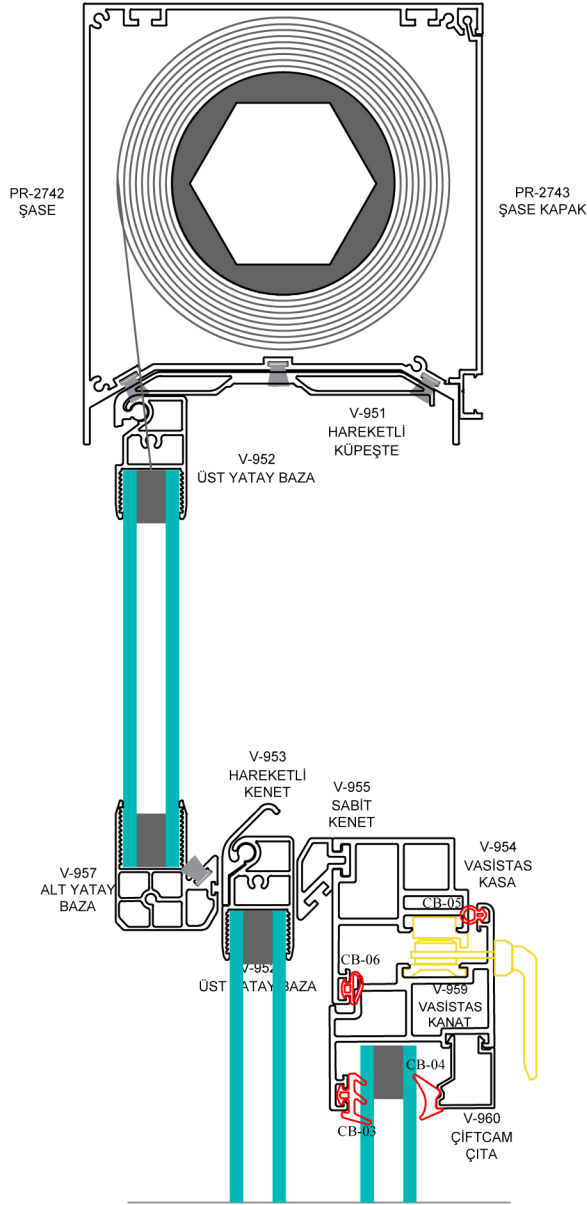
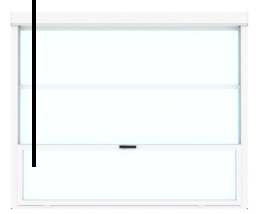

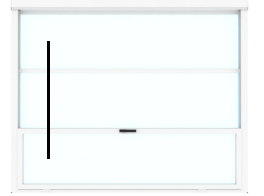

KANAT KİLİTLEME DETAY

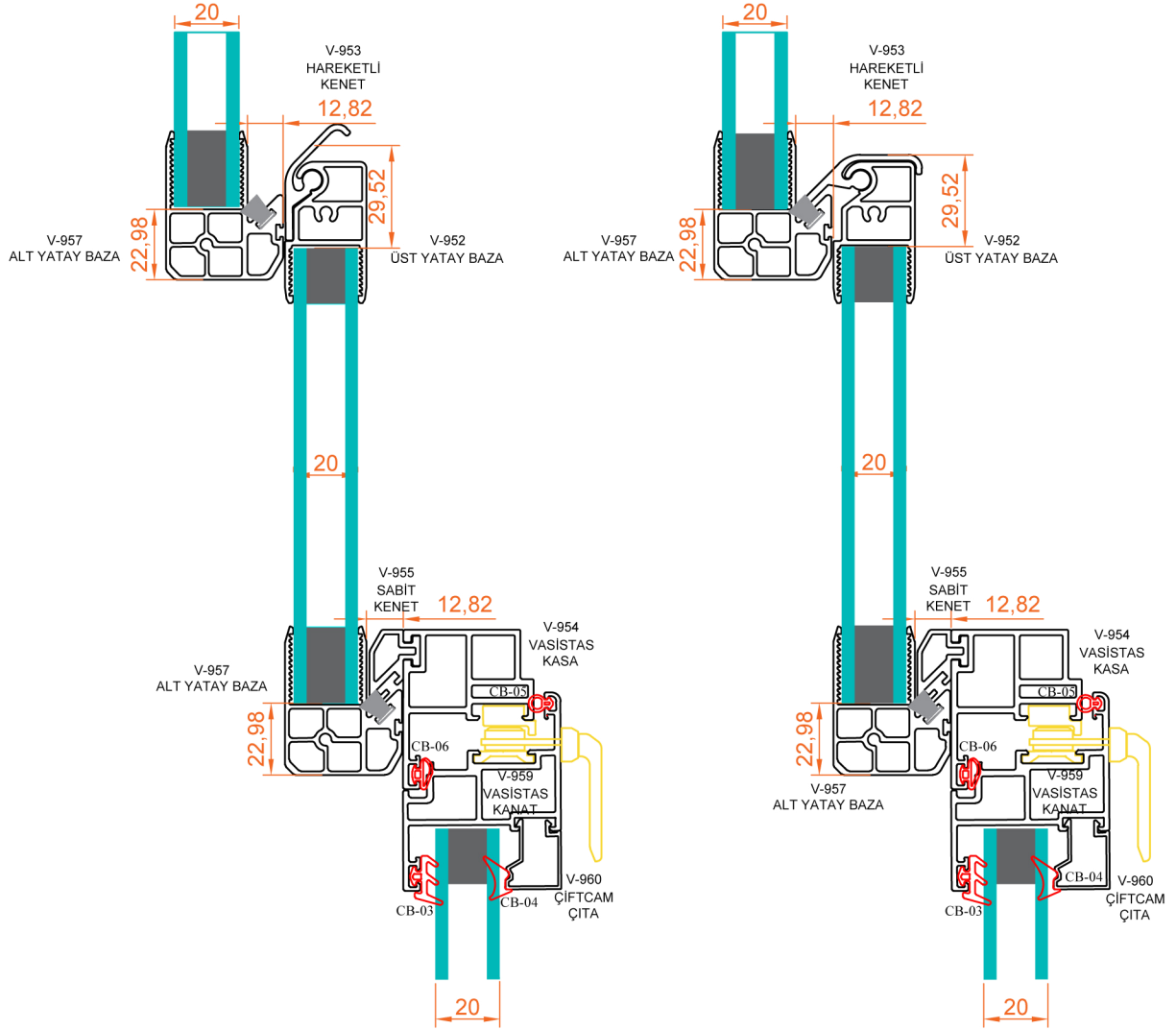



VASİSTAS KANAT AÇILIM DETAY

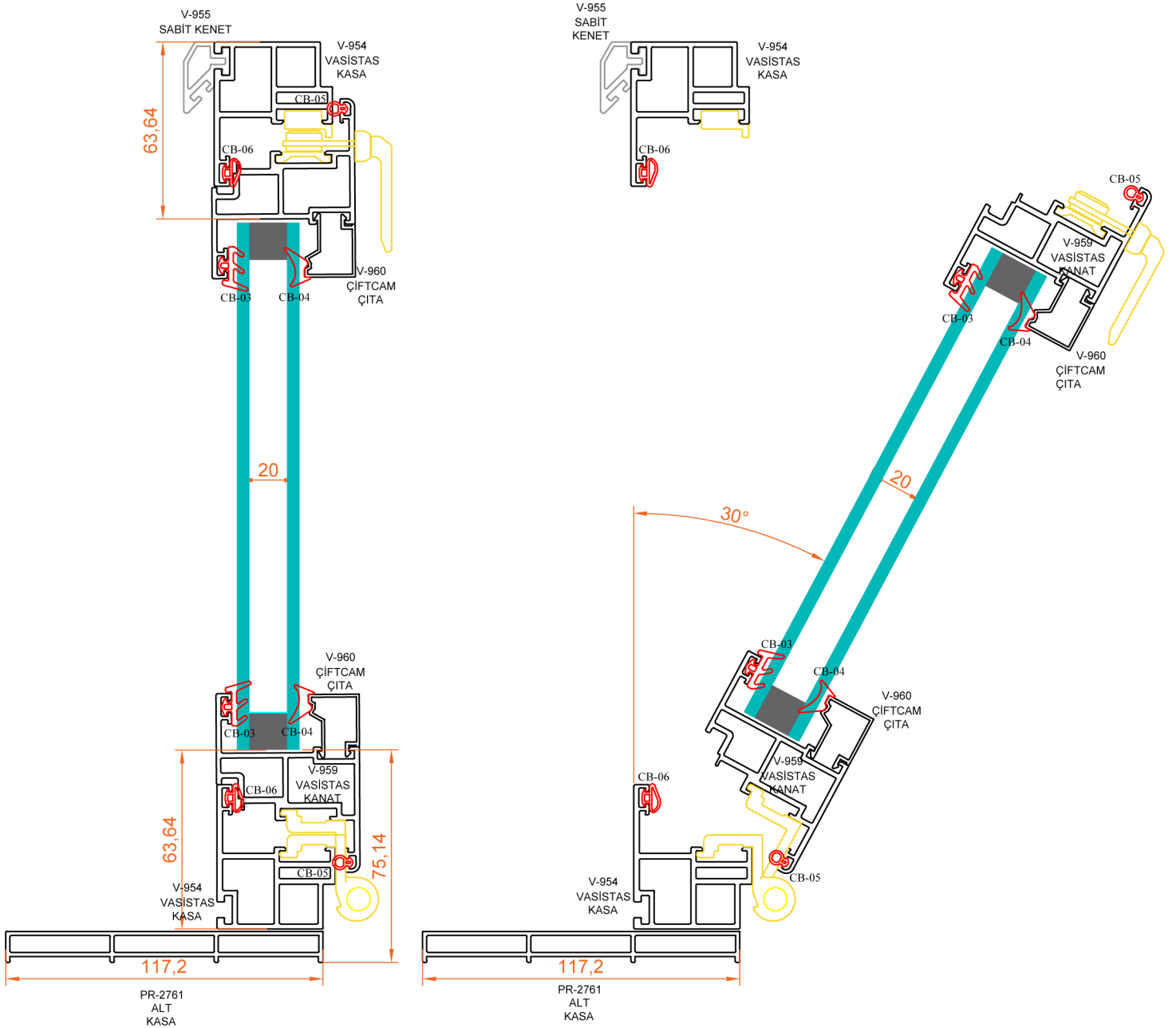
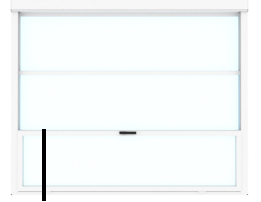

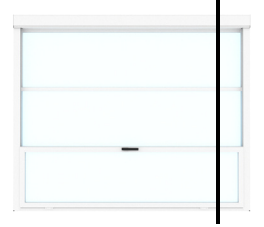

DİZİLİM DETAY

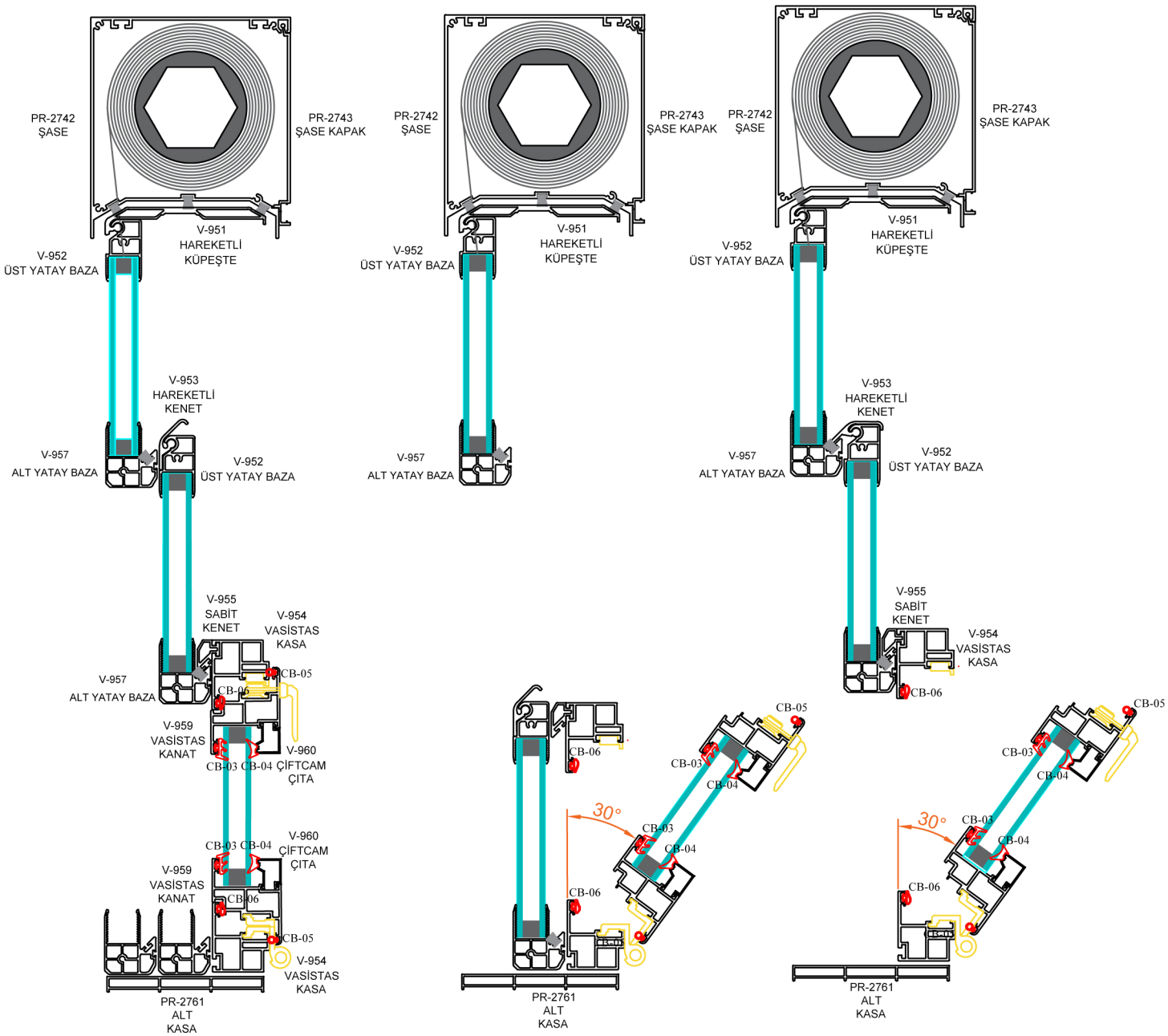



DİZİLİM DETAY

YAN GÖRÜNÜM TİJLİ SİSTEM

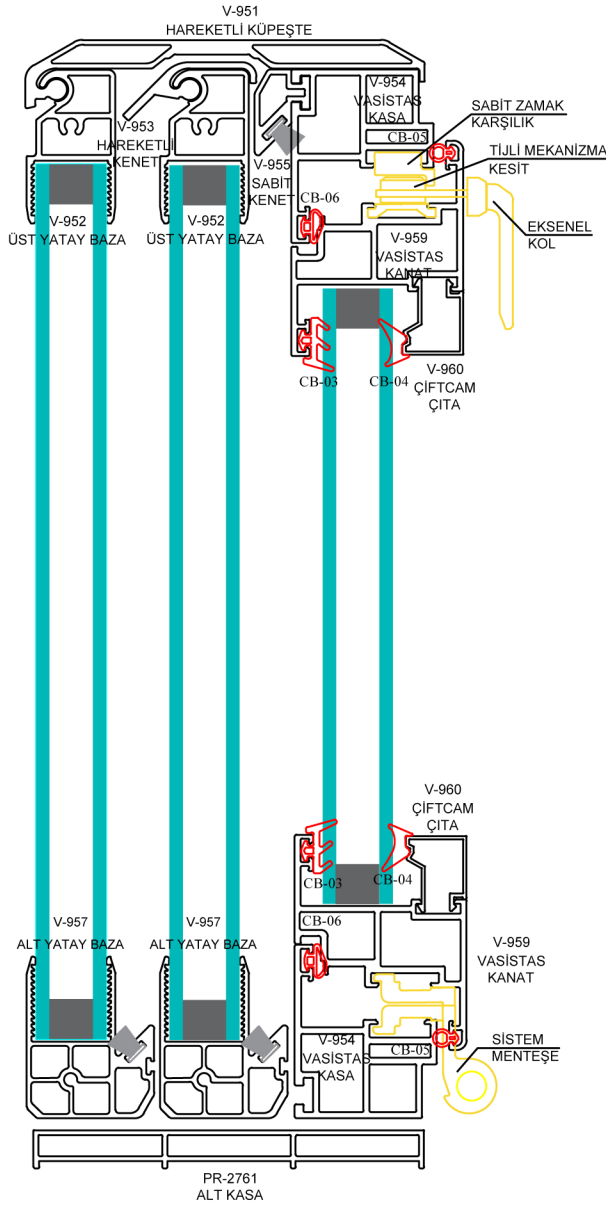

YAN GÖRÜNÜM EURO SİSTEM

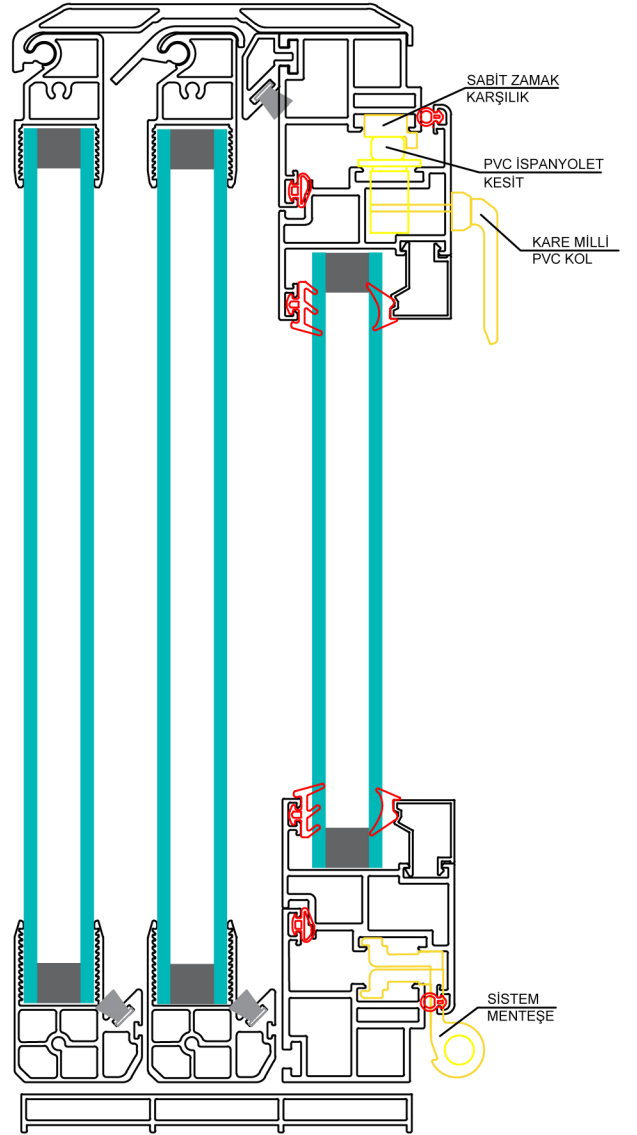



YAN DİKME KAPAK KERTME DETAY

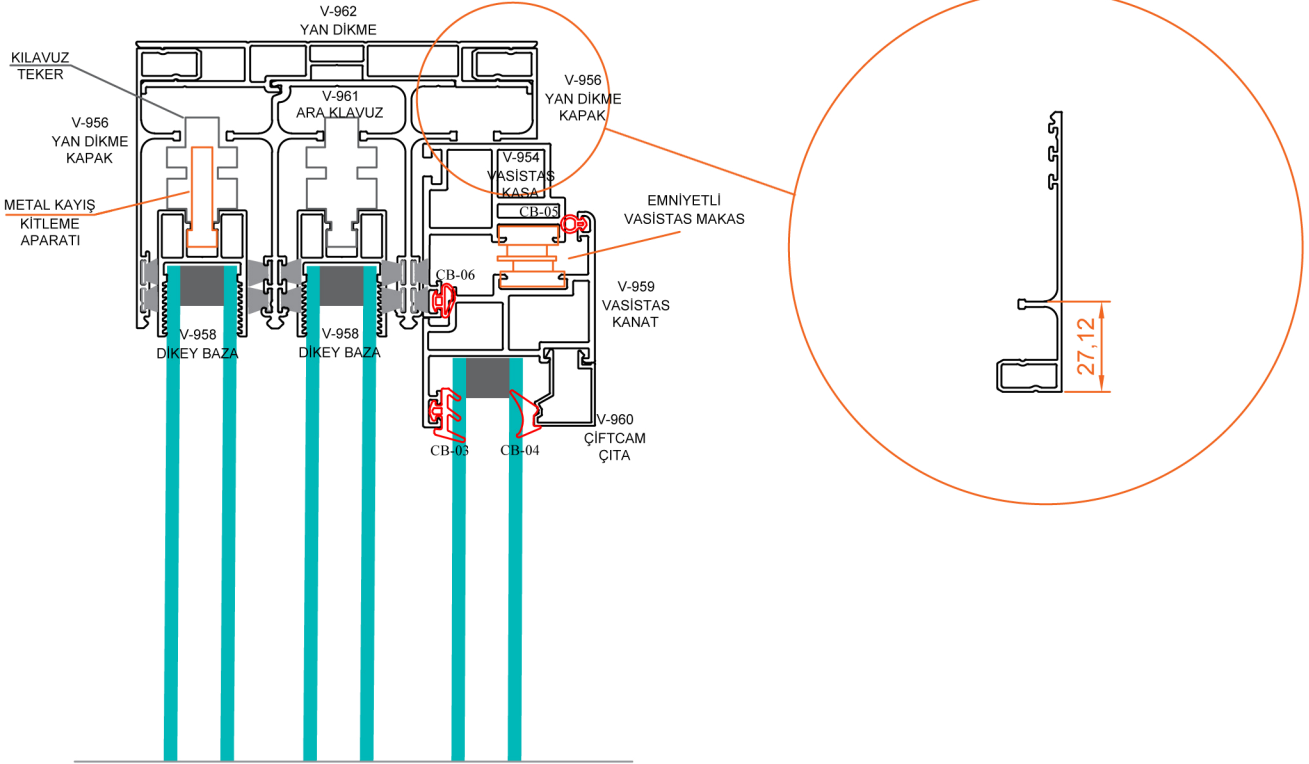



DİZİLİM DETAY



ÜST GÖRÜNÜM

ÜST GÖRÜNÜM

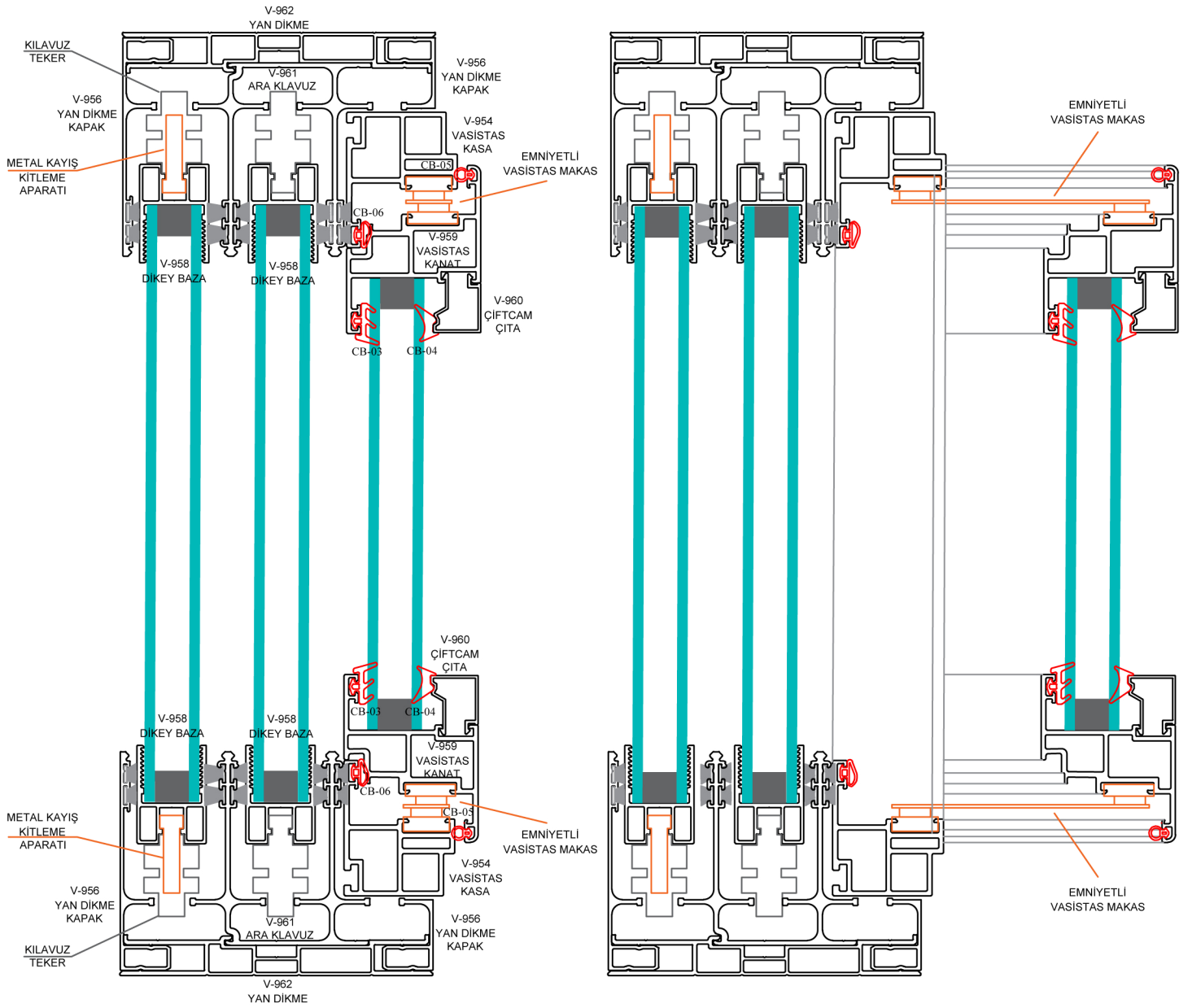



SLIDEX®
Yeni Nesil Katlanır Cam Sistemleri

VİYANA SERİ GİYOTİN SİSTEM
VIENNA SERIES GULLOTINE SYSTEM

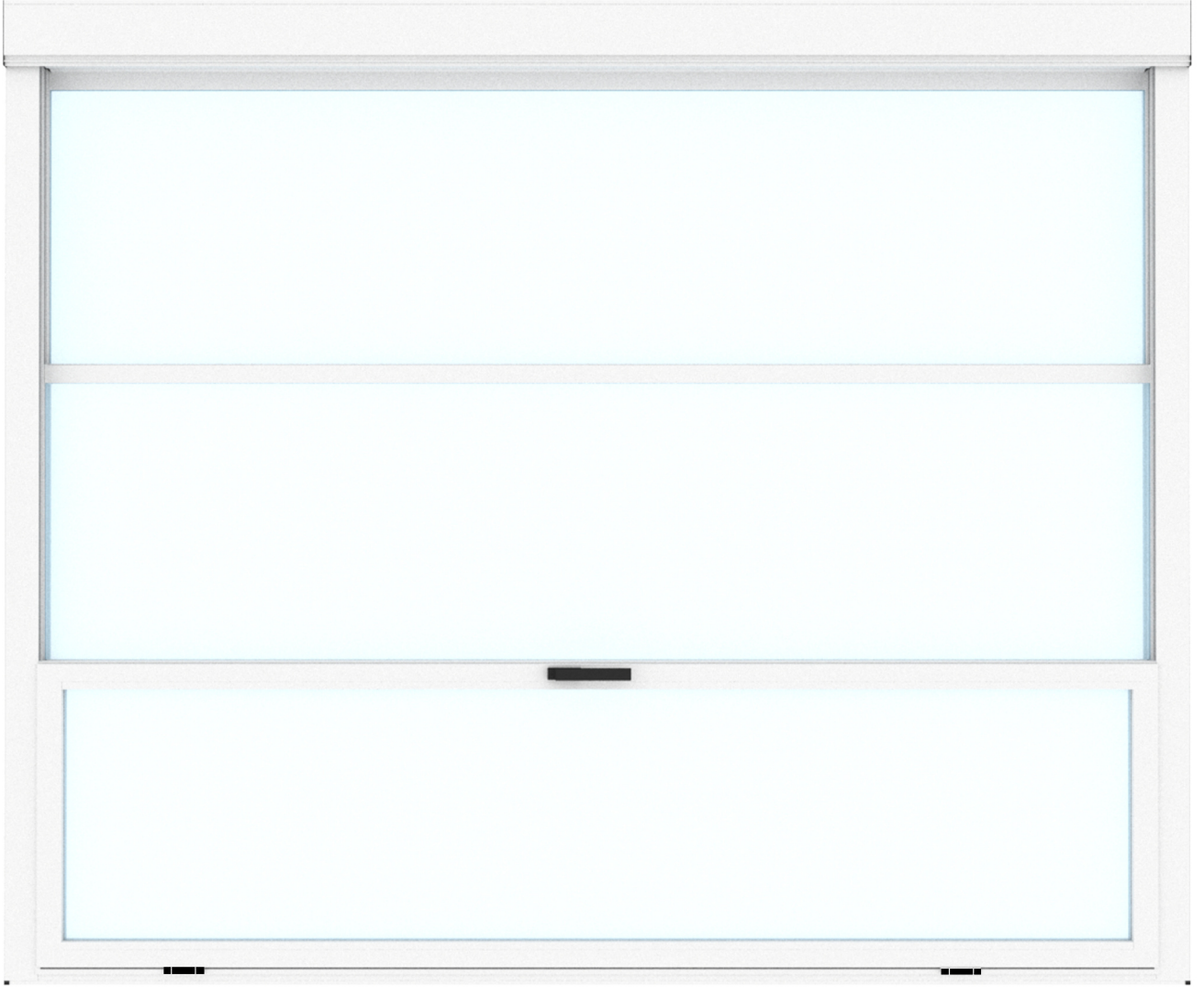

KURULUM

Balüminyum®



VIENNA

SASE KURULUM DETAY

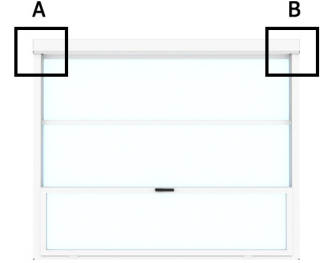

GIYOTİN
KAYIS

TAMBUR
BILEZİK

M.12 RULMAN

SAC KAPAK

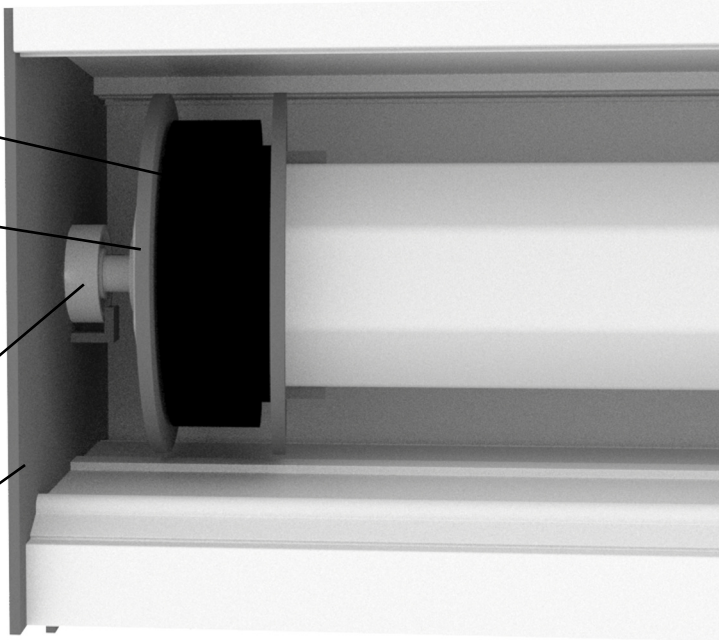

RULMAN DETAY A

Not:
Rulmanı sabitlemek amaçlı 4'lük
setuskur kullanılmaktadır.

MOTOR TARAF DETAY B

Not:
Motor tambur borusuna
kapak montajı yapılmadan
önce takılmalıdır.

TAMBUR
BORUSU

GIYOTİN
KAYIS

TAMBUR
BILEZİK

SAC KAPAK





VIENNA

SASE KURULUM DETAY

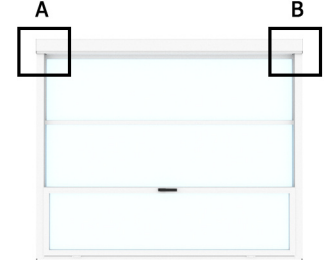
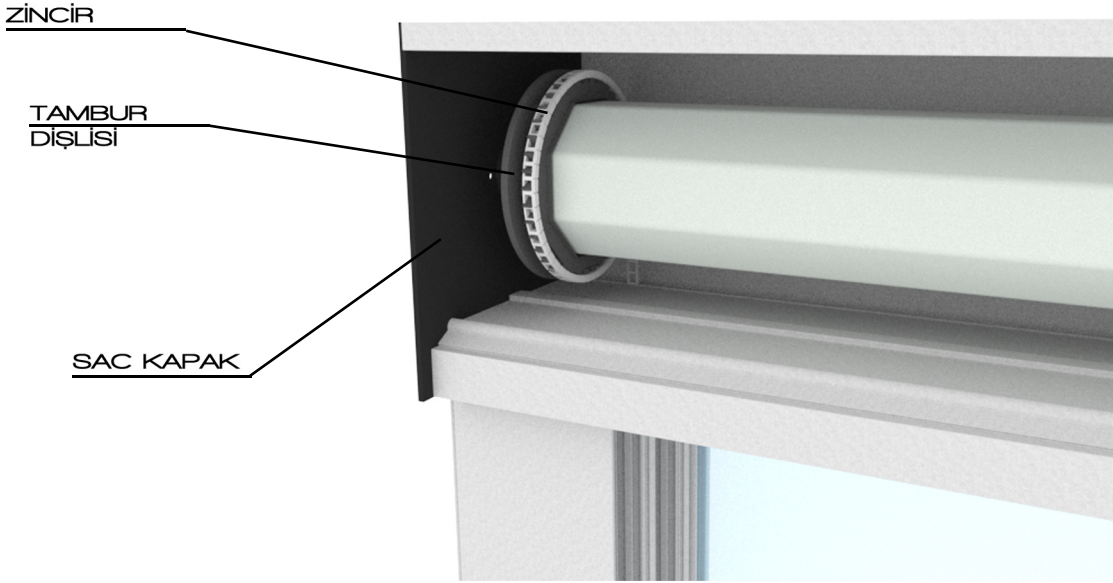

RULMAN DETAY A

Not:
3 mt üzeri sistemlerde
dişli-zincir sistem uygulanabilir.

MOTOR TARAF DETAY B

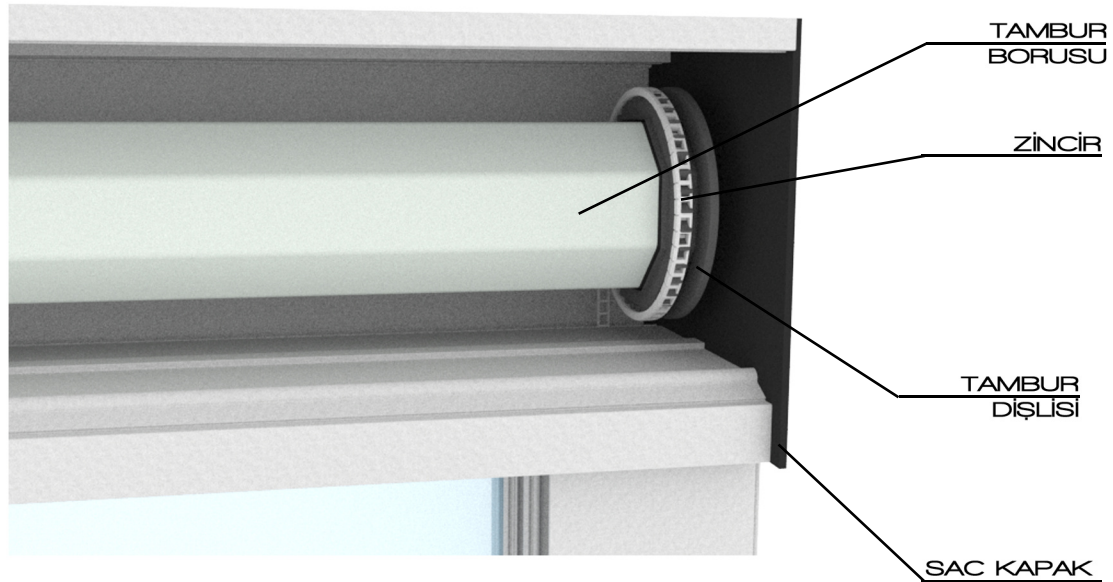



KÜPEŞTE KANAT DETAY

İLK KANAT (KÜPEŞTE KANAT) TASARIM NOTLARI

- V-951 Hareketli Küpeşte Profili, üst yatay bazaya (V-952) aksesuarı takılmadan önce sürerek takılmaktadır.
- Klavuz Aparatları Kanat montajı yapılmadan önce takılmaktadır.

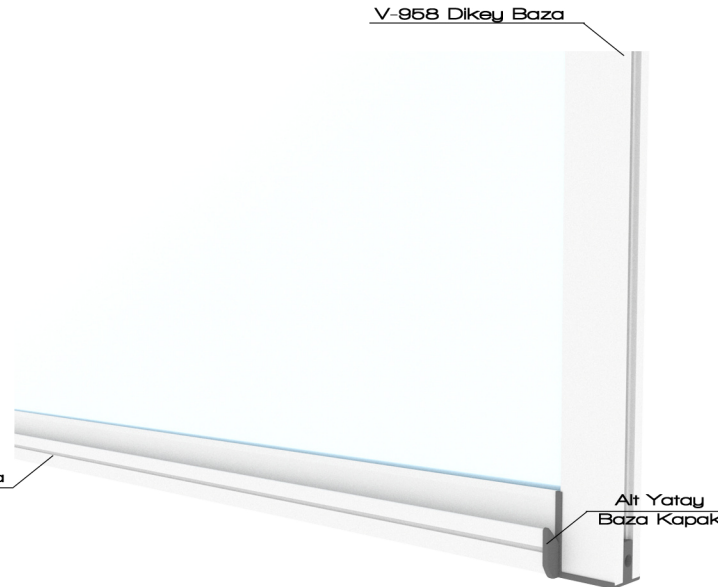
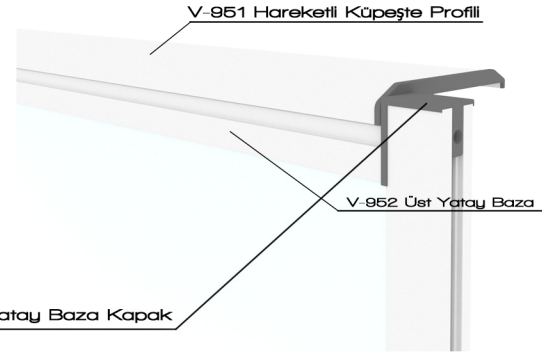
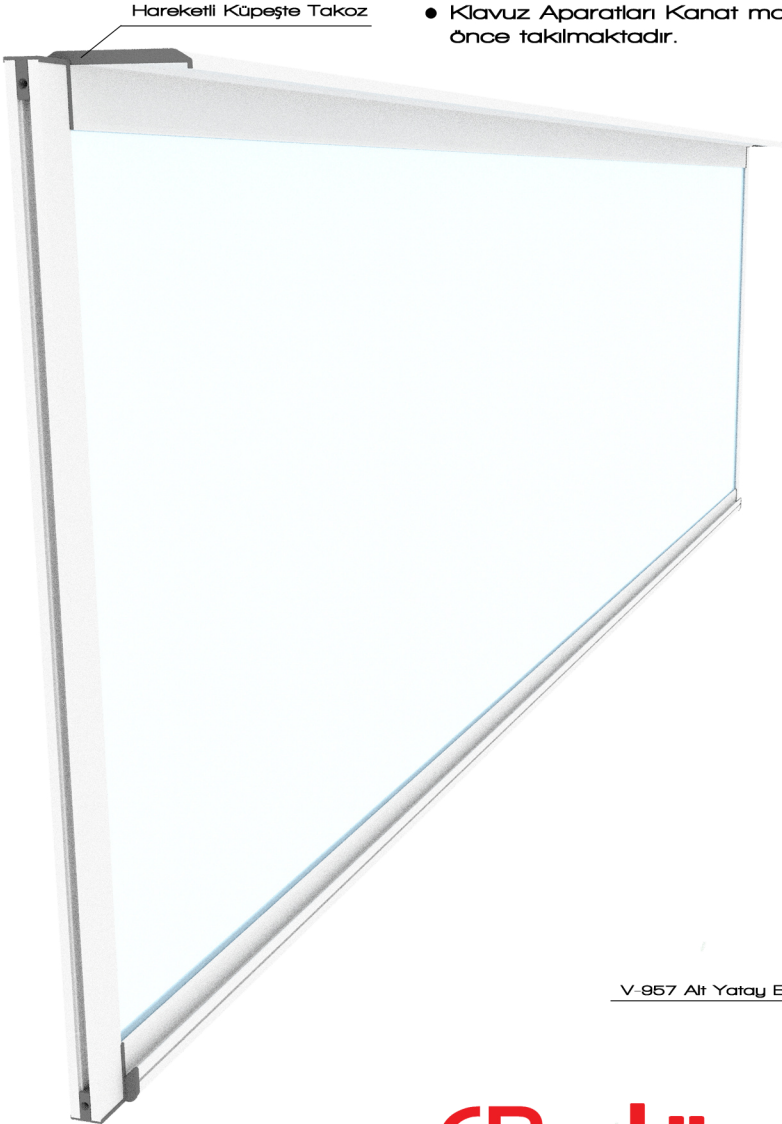



ORTA KANAT DETAY

V-953 Hareketli Kenet

DETAY A

V-958 Dikey Baza



DETAY B

ORTA KANAT TASARIM NOTLARI

- V-953 Hareketli Kenet Profili, üst yatay aksesuarından önce sürerek takılmaktadır.
- V-953 Hareketli Kenet Profili, ilk kanat kenetlenmeden önce manuel olarak aşağı-yukarı yönde bastırılmalıdır (Bu detay orta kanada ve ilk kanada silinebilir özellik katmaktadır).
- Kılavuz aparatı kanat birleşimi yapılmadan önce takılmaktadır.

V-957 Alt Yatay Baza

Alt Yatay Baza Kapak



VASİSTAS KANAT DETAY

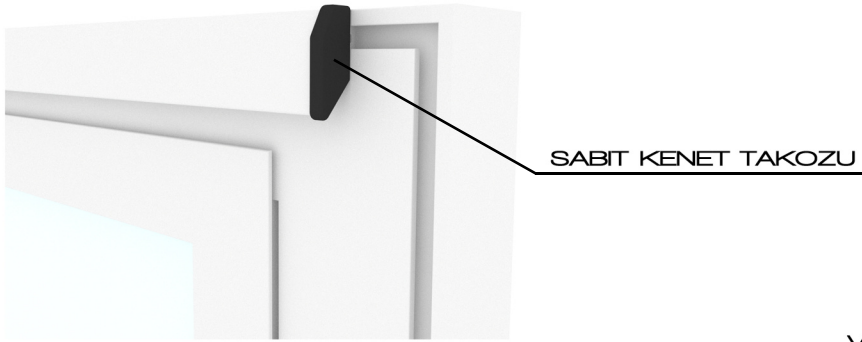

SABIT KENET TAKOZU

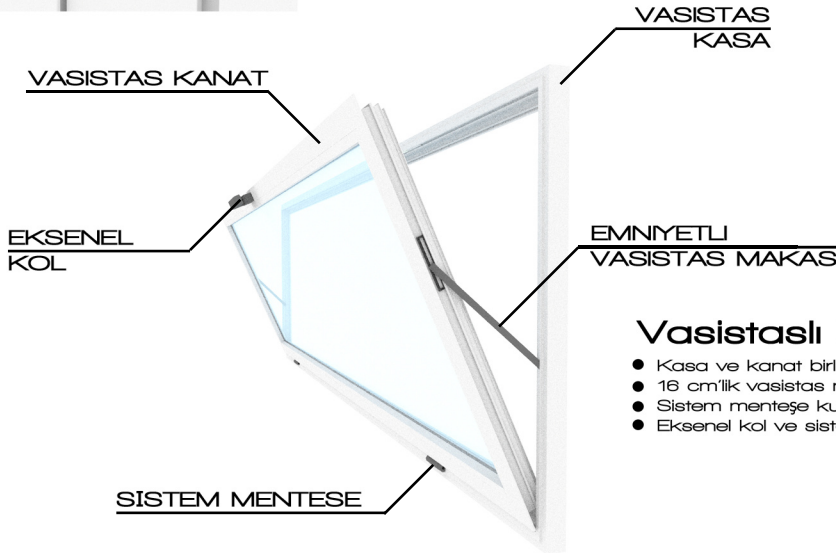

VASİSTAS KANAT

VASİSTAS KASA

EKSENEL KOL

EMNİYETLİ VASİSTAS MAKAS

SİSTEM MENTESE



Vasistaslı Kanat Tasarım Notları:

- Kasa ve kanat birleşimlerinde köşe gönyeleri kullanılmaktadır.
- 16 cm'lik vasistas makas kullanılması tavsiye edilmektedir.
- Sistem menteşe kullanılması zorunludur.
- Eksenel kol ve sistem tij standartlarına uyulmuştur.

VASİSTAS ÇITA

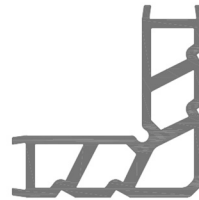

KASA GÖNYE
70-3084
3,206 gr/m



KANAT GÖNYE
70-3078
2,345 gr/m



CB-08
HORTUM CONTA



CB-05
KANAT CONTA



CB-04
SAPLAMA CONTA



CB-03
KANAT CAM CONTA

ALT KÖSE TAKOZU



VİYANA SET

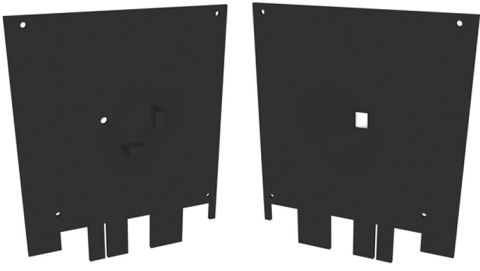

SAC ŞASE KAPAK

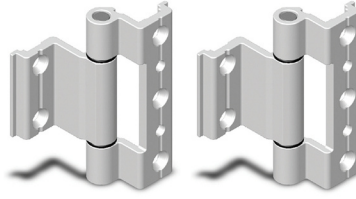

MENTEŞE



VASİSTAS MAKAS
(KALE)

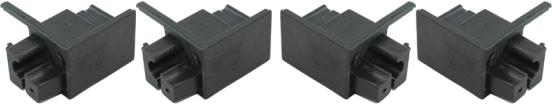

ÜST YATAY BAZA
KAPAK



SABİT KENET
TAKOZ



KLAVUZ APARAT



ALT YATAY BAZA
KAPAK



M12
RULMAN



PİMLİ BORU
BAŞI



KAYIŞ KİLİTLEME



ALT KÖŞE TAKOZ

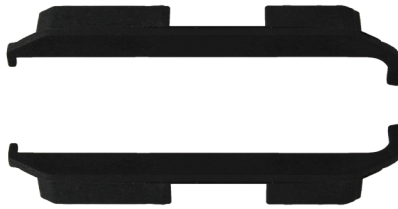

KÜPEŞTE TAKOZ

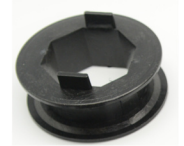

TAMBUR BİLEZİK



AKSESUARLAR



SABİT ZAMAK
KARŞILIK



EKSENEL KOL



GİYOTİN KAYIŞ



S GATE
MOTOR



SİSTEM TİJ



TİJ PİM TAKIM



S GATE
KUMANDA



KİL FİTİL
6,7*600 - 6,7*1000
4,8*600



ZİNCİR - DİŞLİ TAKIM



CB-06

HORTUM CONTA



CB-05

KANAT CONTA



CB-04

SAPLAMA CONTA



CB-03

KANAT CAM CONTA



VIENNA

SİLİNEBİLİR GİYOTİN



Balüminyum®

CB BOND



Adres :

İvedik OSB Mah.

Havalandırmacılar Cad. No :73-80-82

Yenimahalle /ANKARA

Telefon & Fax :

Telefon : 0312 386 07 64

Telefon : 0850 888 43 33

Fax : 0312 386 08 64

İnternet :

www.cbaluminyum.com.tr

www.slidex.com.tr

info@slidex.com.tr

info@cbaluminyum.com

