

ENERJİ VERİMLİLİĞİNİN GELECEĞİ

- 21 mm Temperli Isıcam
- Takviye Fitol Seçeneği İle Maksimum Yükseklik Direnci
- Paslanmaz Çelik Tekerlek
- Yeni Nesil Ergonomik Tasarım
- Maksimum Su ve Hava Geçirmezlik
- Termal Cam Özelliği İle Üstün Isı ve Ses Yalıtımı
- Özel Punch Sistemi ile İmalat Kolaylığı
- Ek Ray Özelliği İle Sonsuz Kanat Sayısı
- Zengin Kilit Seçeneği



NEWYORK
ISICAMLI SÜRME SİSTEM

 **NEWYORK**

PROFİLLER

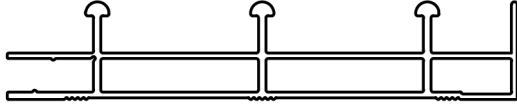

NW-3258
1097 gr/mt
3'lü Alt Ray

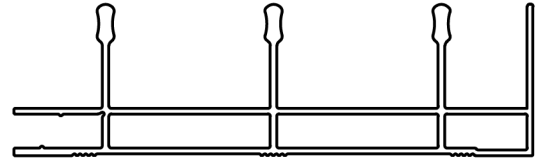

NW-3259
1279 gr/mt
3'lü Üst Ray

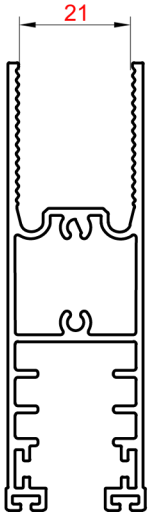

NW-3266
1119 gr/mt
Baza

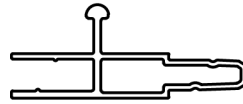

NW-3261
469 gr/mt
Alt Ray Ek

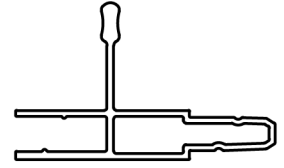

NW-3262
518 gr/mt
Üst Ray Ek



NW-3263
404 gr/mt
Yan Dikme Ek

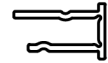

NW-3264
122 gr/mt
Kapak Profil



NW-3260
845 gr/mt
3'lü Yan Dikme

 **NEWYORK**

PROFİLLER

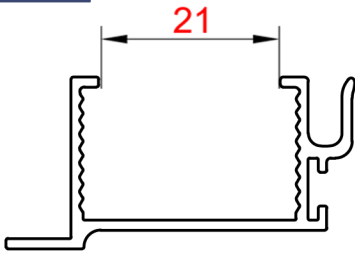

NW-3265
314 gr/mt
Tırnaklı Çekme Çıta



NW-10747
279 gr/mt
Tırnaksız Çekme Çıta

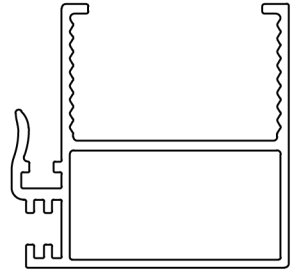

NW-3641
449 gr/mt
Takviyeli Çekme Çıta

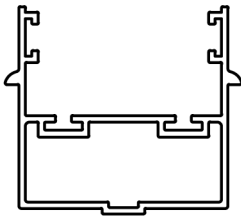

NW-10749
585 gr/mt
Uzun U Profil



NW-3268
520 gr/mt
Kısa U Profil

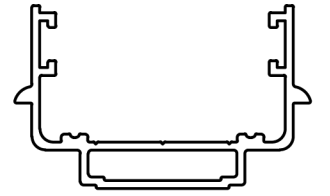

NW-3640
463 gr/mt
Bağlantı Adaptör

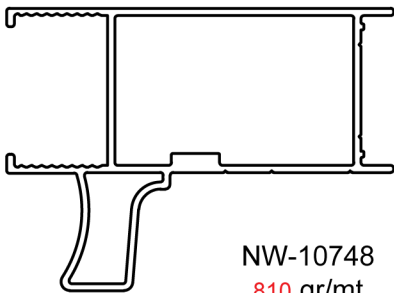

NW-10748
810 gr/mt
Tek Taraflı Kulp Profil

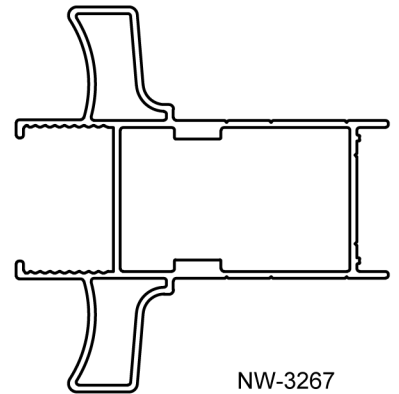

NW-3267
1029 gr/mt
Çift Taraflı Kulp Profil

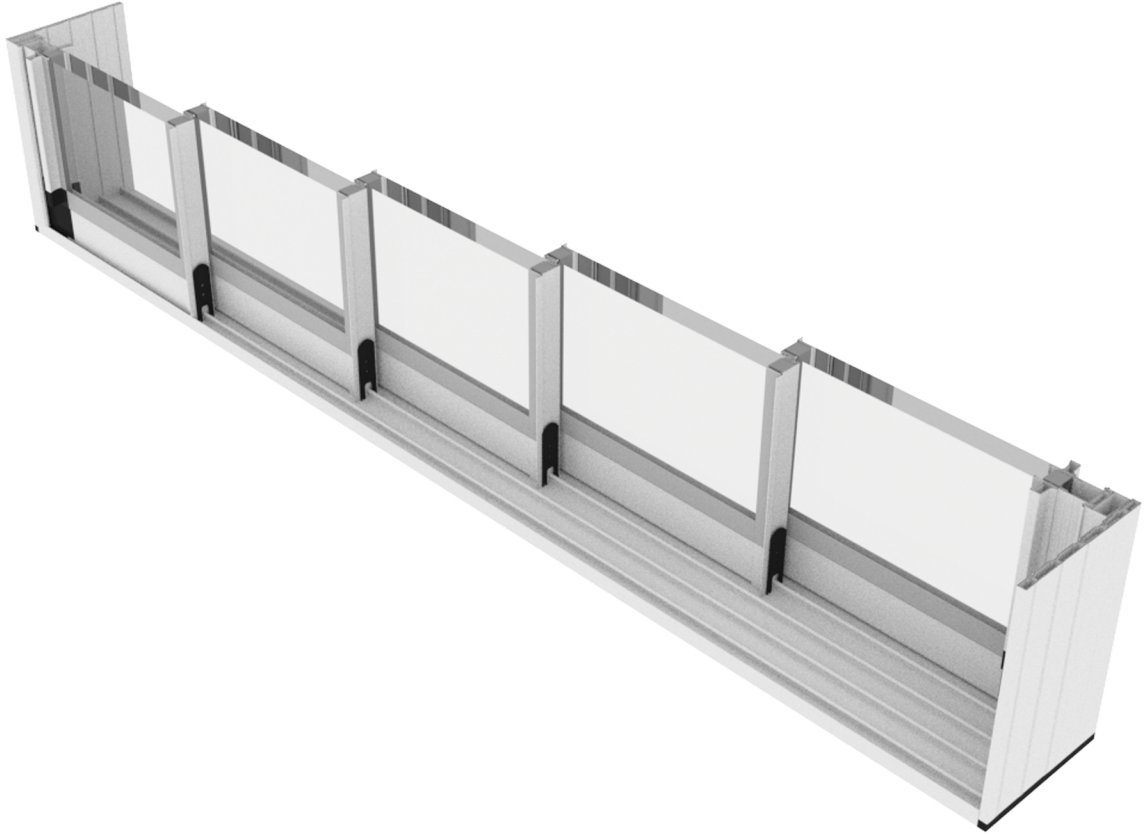

DETAY

 **NEWYORK**

DİZİLİM

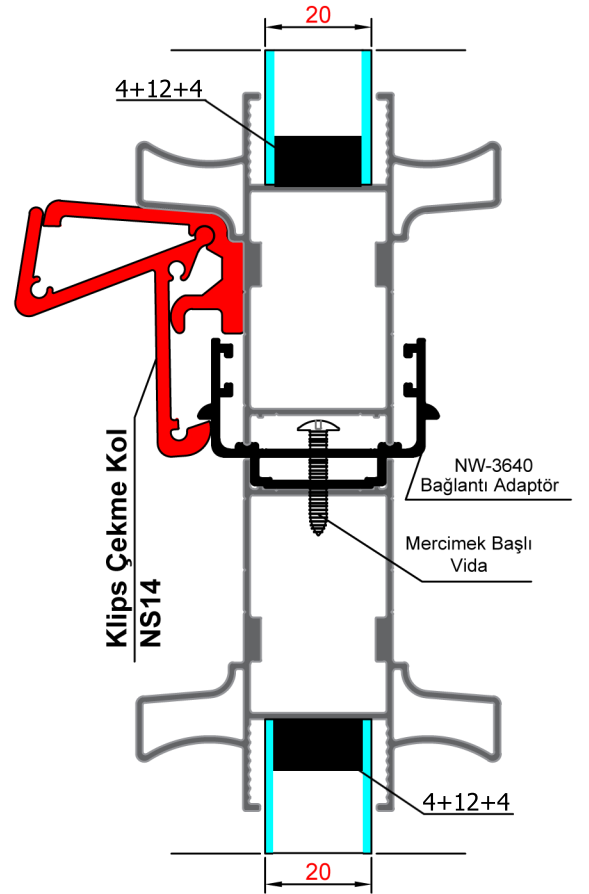
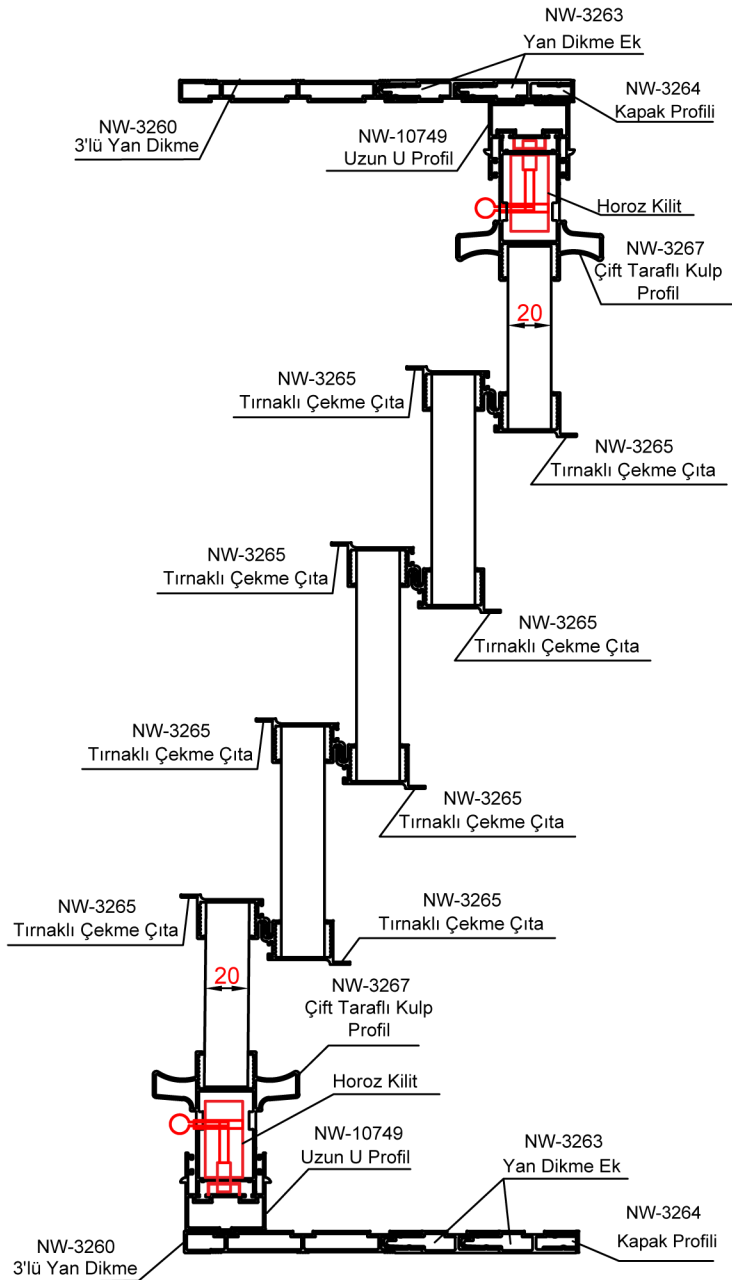
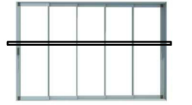



SONSUZ RAY EKLEME ÖZELLİK

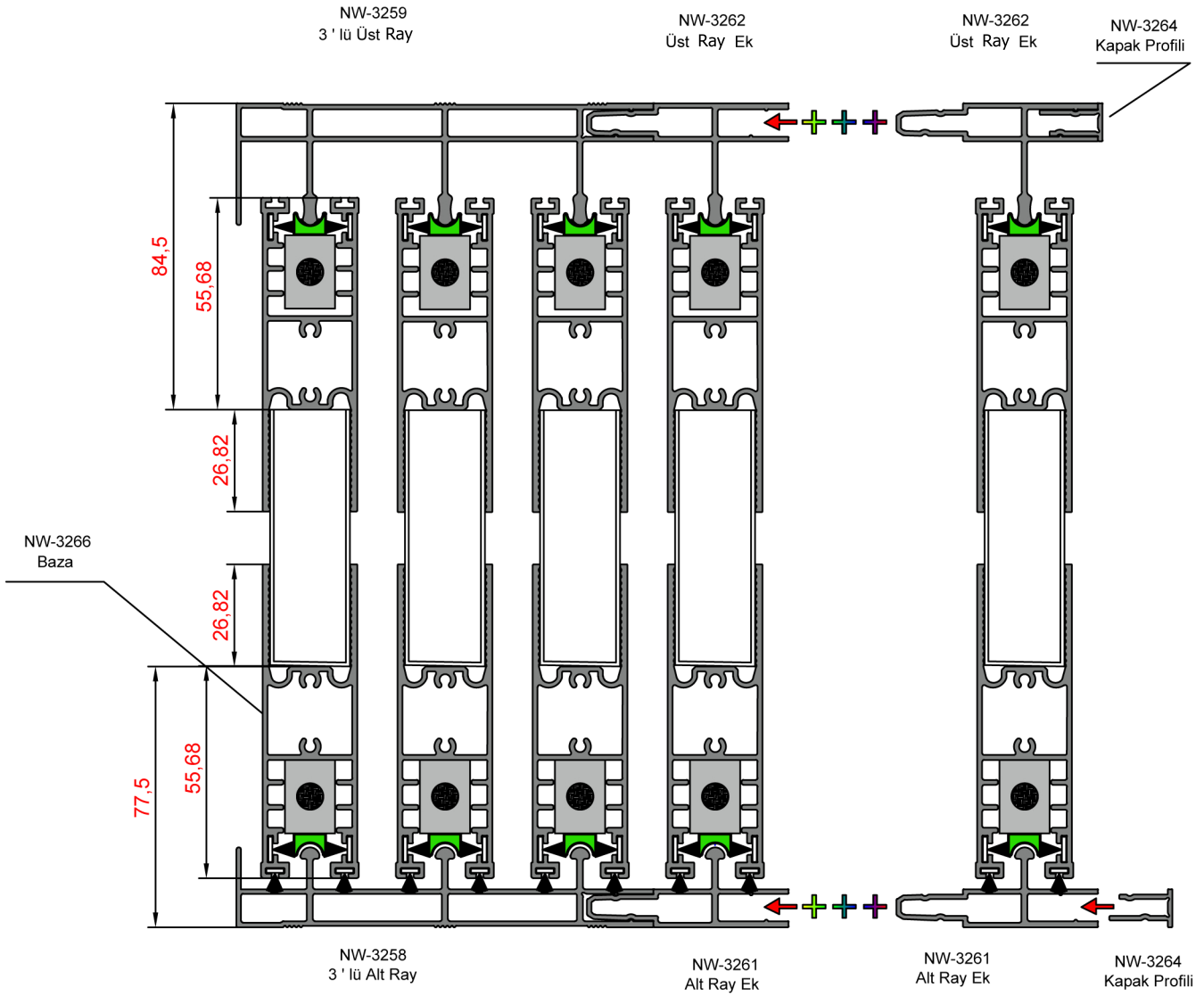
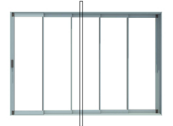



KURULUM

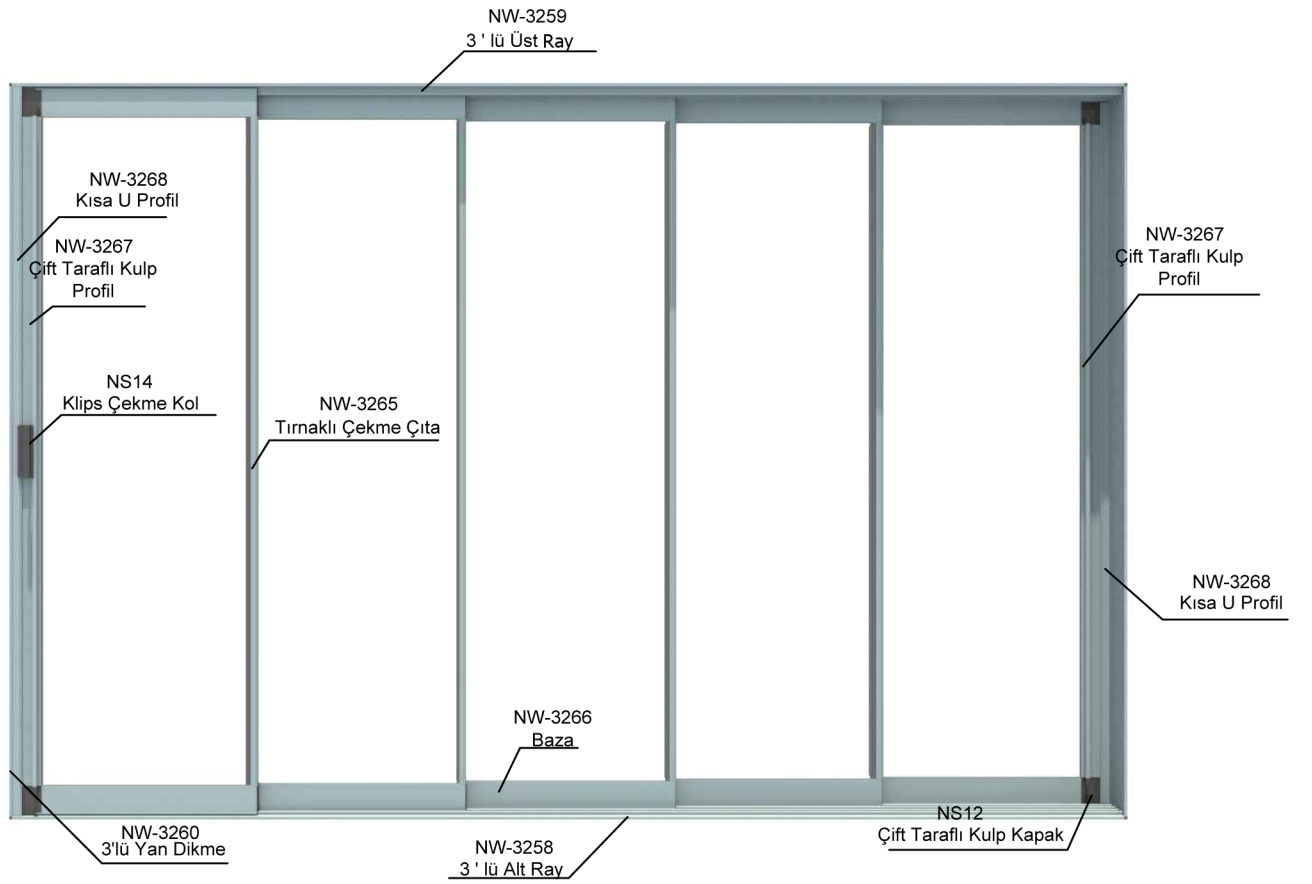

KURULUM

NOT: 2' ŞER ADET EK RAY PROFİLLERİ KULLANILMIŞTIR.

 **NEWYORK**

ÜST KÖŞE DETAY

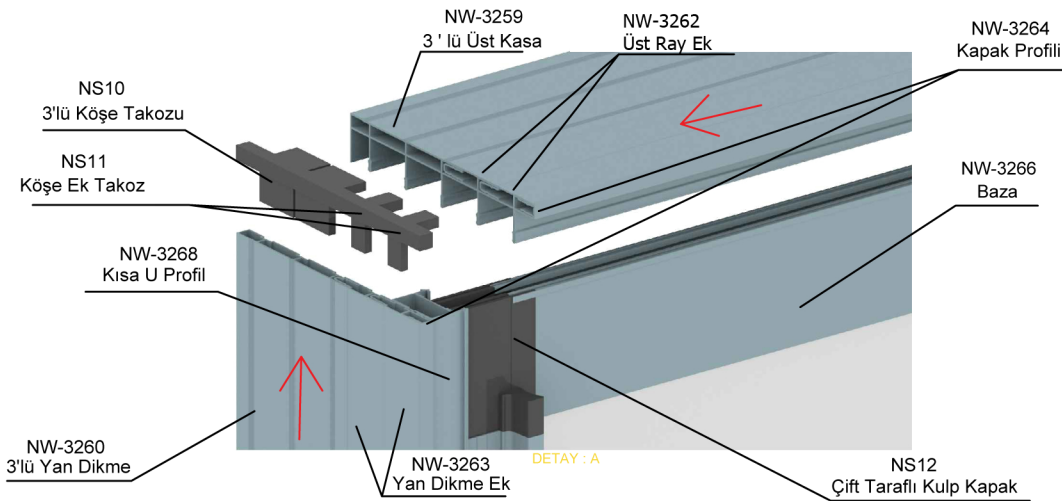
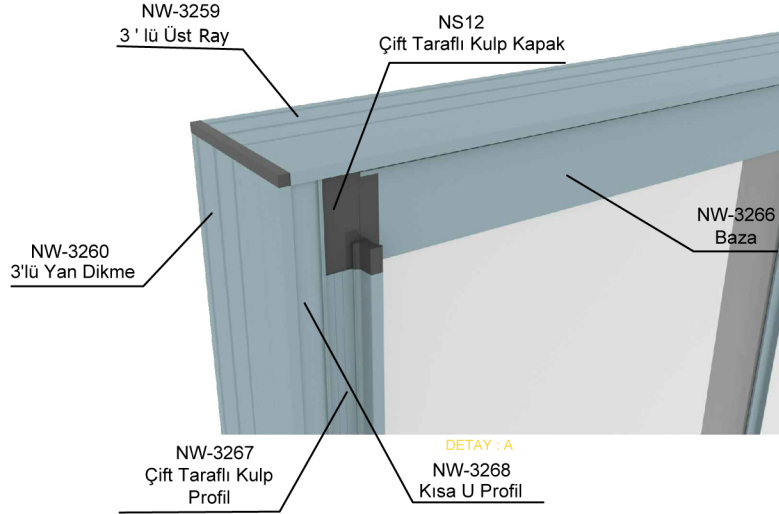

 **NEWYORK**

ALT KÖŞE DETAY

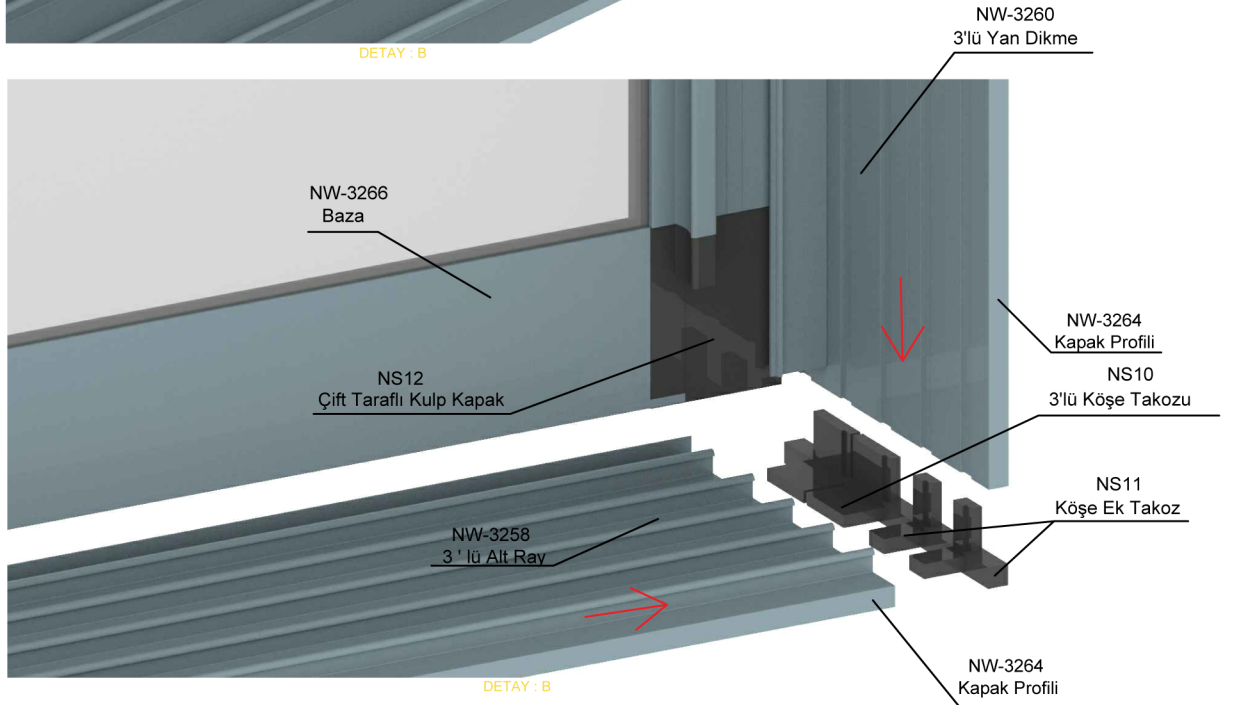
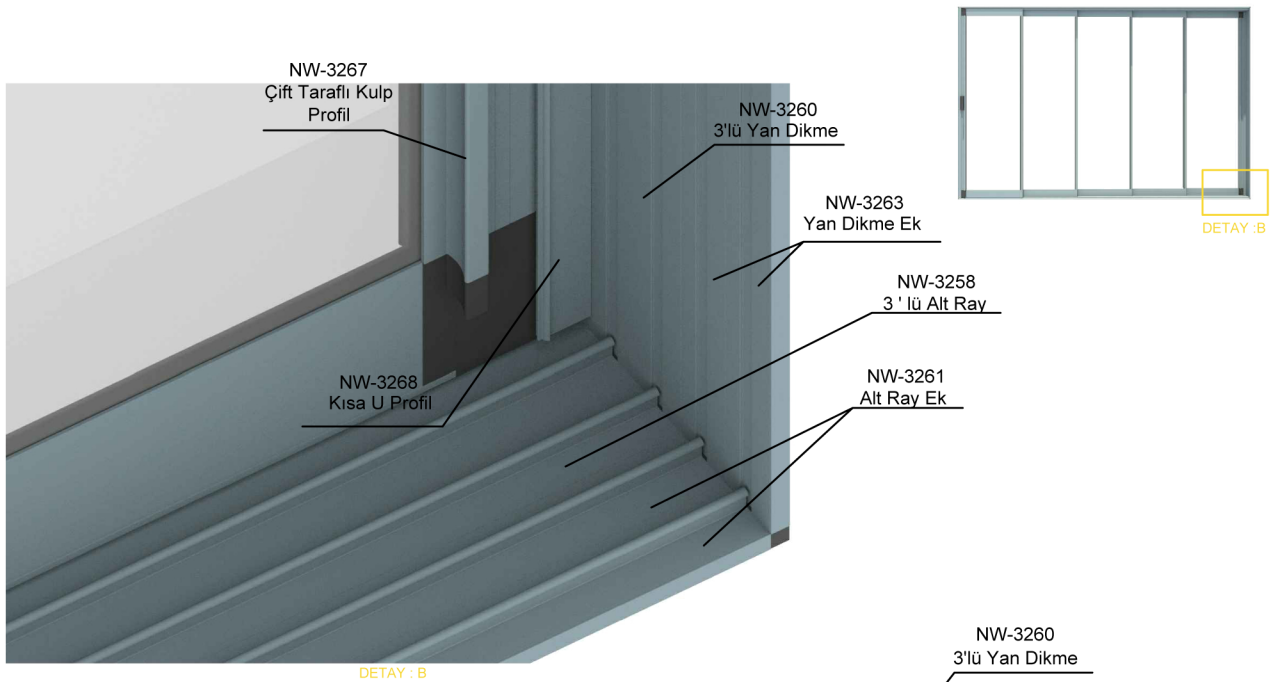

 **NEWYORK**

KURULUM DETAY

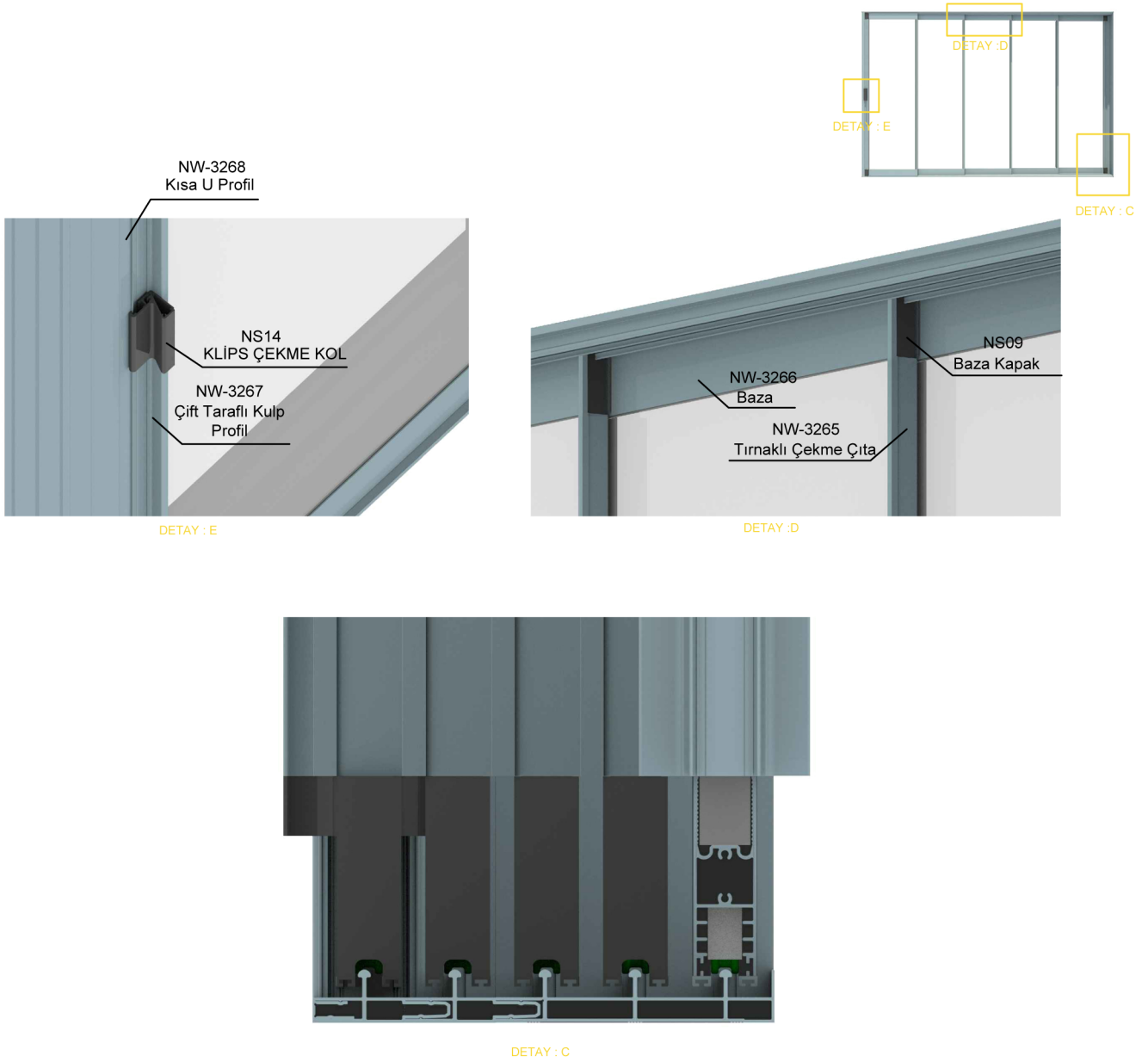

 **NEWYORK**

KANAT KİLİTLEME DETAY

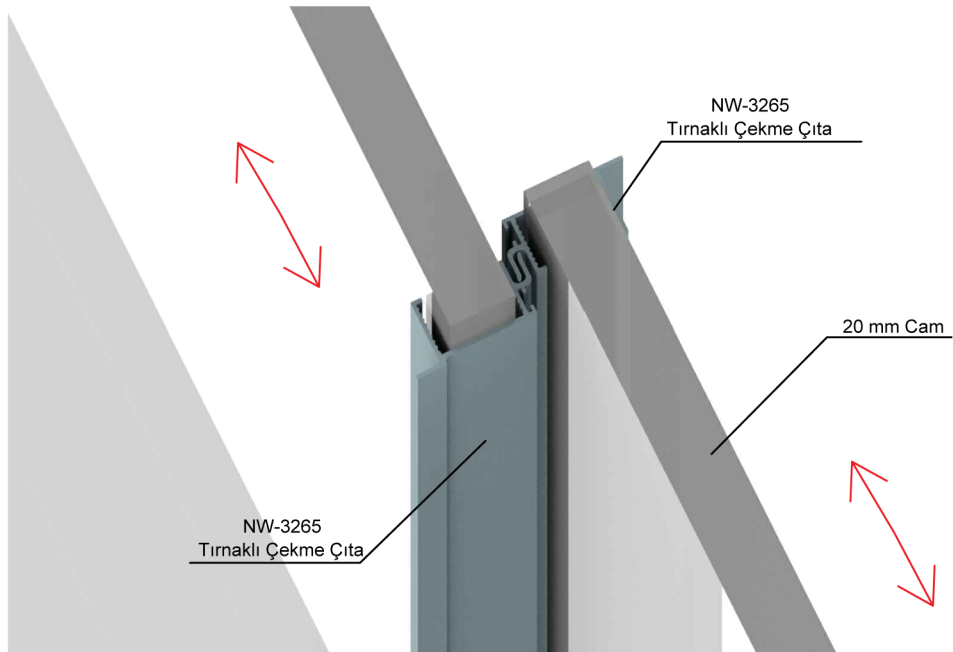
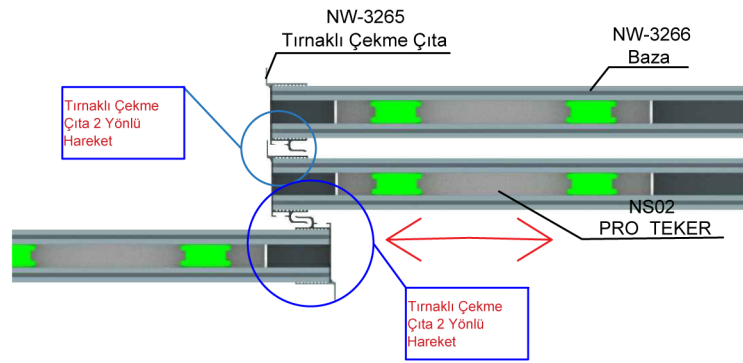



NEWYORK

ISICAMLI SÜRME SİSTEM ÇEKME ÇITA PUNCH DETAY

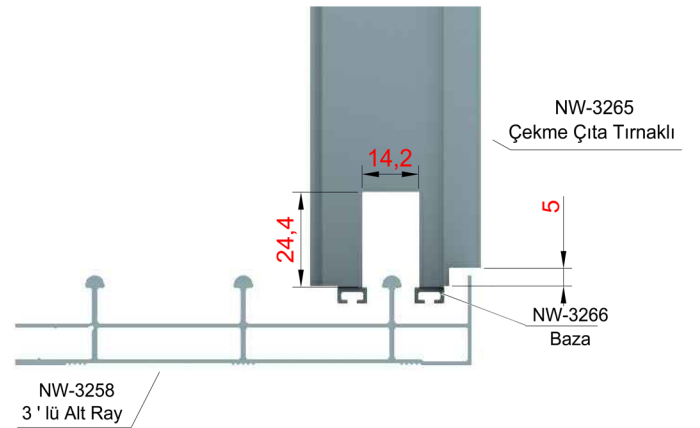
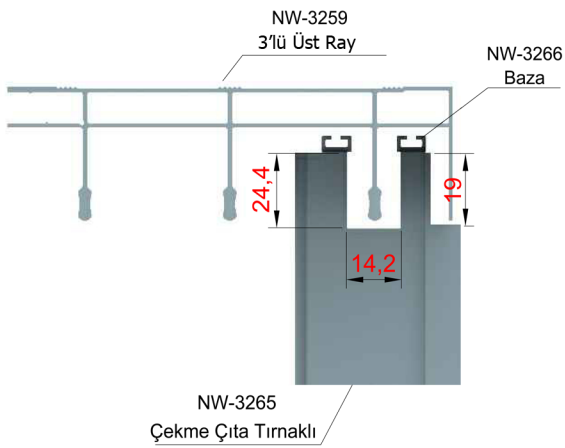
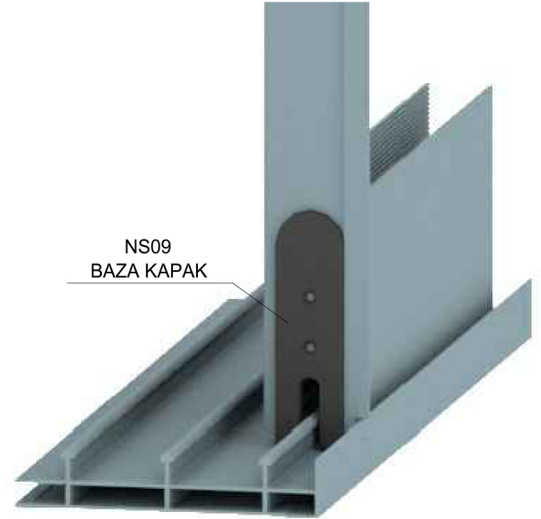

NOT: BU PUNCH İŞLEMİ (NW-10747) TIRNAKSIZ ÇEKME FİTİLDE DE UYGULANABİLMEKTEDİR.

 **NEWYORK**

KISA VE UZUN U PROFİL PUNCH DETAY

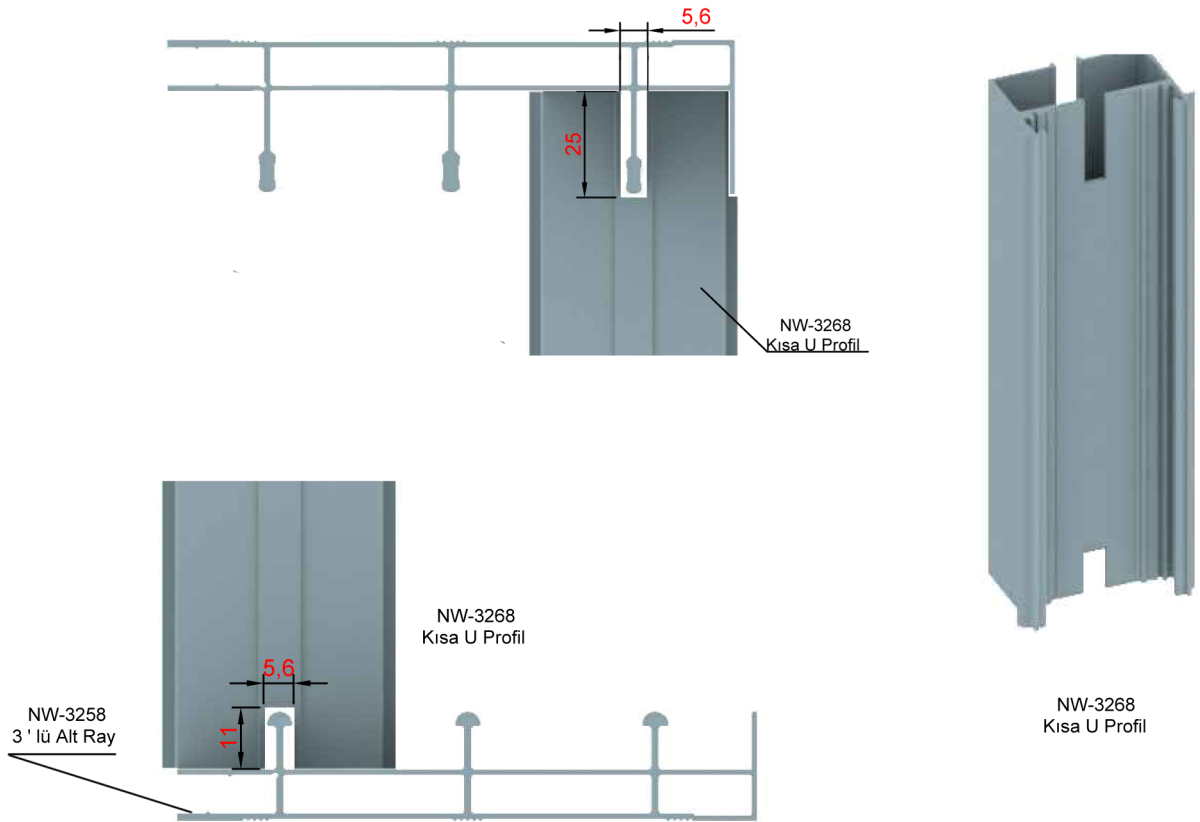

NOT: BU PUNCH İŞLEMİ (10749) UZUN U PROFİLİNDE DE UYGULANABİLMEKTEDİR.

 **NEWYORK**

KULP PROFİLİ PUNCH DETAY

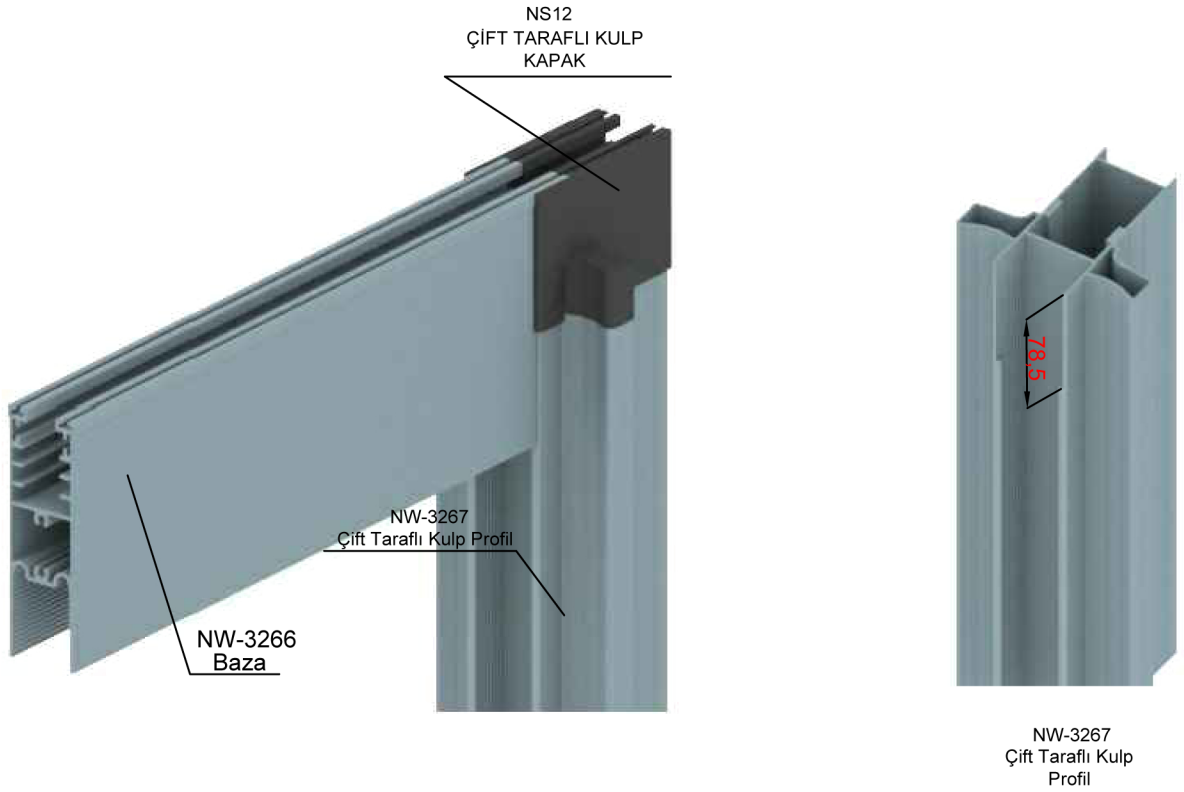

NOT: BU PUNCH İŞLEMİ (10748) TEK TARAFLI KULP PROFİLİNDE DE UYGULANABİLMEKTEDİR.

 **NEWYORK**

AKSESUARLAR



NS09
BAZA KAPAK



NS10
3'LÜ KÖŞE TAKOZU



NS11
KÖŞE EK TAKOZ



NS12
ÇİFT TARAFLI KULP
KAPAK



NS20
TEK TARAFLI KULP
KAPAK



NS02
PRO TEKER



NS14
KLIPS ÇEKME KOL



NS17
HAVUZ KİLİT



NS18
HOROZ KİLİT



NEWYORK

ISICAMLI SÜRME SİSTEM



Balüminyum®

CB BOND



Adres :

İvedik OSB Mah.

Havalandırmacılar Cad. No :73-80-82

Yenimahalle /ANKARA

Telefon & Fax :

Telefon : 0312 386 07 64

Telefon : 0850 888 43 33

Fax : 0312 386 08 64

İnternet :

www.cbaluminyum.com.tr

www.slidex.com.tr

info@slidex.com.tr

info@cbaluminyum.com

